



DS-2XM6222G1-ID /R M2M

Caméra 2MP 110°, focale fixe 2.8mm, IR 850nm 10m, IP68, WDR 120dB, H265, grande tenue aux vibrations, Cybersafe

2MP

110°

IR 850nm

WDR 120dB

H265

VIBRATIONS

PoE

CYBERSAFE



- Capteur CMOS 2MP 1280x1080 pixels
- Couverture angulaire horizontale 110°
- Focale fixe 2.8mm
- WDR 120dB
- Sensibilité : 0.01 Lux @ (F1.6, AGC ON)
- IR discret 850nm jusqu'à 10 mètres
- Enregistrement local sur micro SD
- Large plage d'alimentation 9-36V DC ou PoE
- Compression H265, H264, MJPEG
- ONVIF
- IP68
- Certifications automobiles et ferroviaires
- Cybersafe



DS-2XM6222G1-ID /R M2M

Caméra 2MP 110°, focale fixe 2.8mm, IR 850nm 10m, IP68, WDR 120dB, H265, grande tenue aux vibrations, Cybersafe

SPECIFICATIONS TECHNIQUES

Caméra	
Modèle	DS-2XM6222G1-ID /R M2M
Capteur	1/ 2.8" Progressive Scan CMOS
Compression vidéo	H265/H.264/MJPEG
Bitrate	256kbps à 16Mbps
Vidéo	Flux 1 : 50 Hz : 25 fps (1920 × 1080, 704 × 576, 640 × 480, 352 × 288) Flux 2 : 50 Hz : 25 fps (1920 × 1080, 704 × 576, 640 × 480, 352 × 288) Flux 3 : 50 Hz : 25 fps (1920 × 1080, 704 × 576, 640 × 480, 352 × 288)
Optique	
Focale	2.8mm fixe
Angles de vue	Horizontal FOV 110°, vertical FOV 56°, diagonal FOV 126°
Ouverture	F1.6
Eclairage	
Type	IR 850nm
Distance	Jusqu'à 10 mètres
Evènements	
Basique	Motion detection, video tampering alarm, alarm input and output, exception
Smart	Line crossing detection, intrusion detection, region entrance detection, region exiting detection, unattended baggage detection, object removal detection, object detection: detects faces and upload images, Scene change detection, defocus detection
Stockage	
Local	Carte MicroSD/SDHC/SDXC (max. 256 GB)
Réseau	
Protocoles	TCP/IP, HTTP, DHCP, DNS, DDNS, RTP, RTSP, PPPoE, SMTP, NTP, UPnP, SNMP, FTP, 802.1x, QoS, HTTPS, IPv6 (SIP, SRTP optionnel)
Standard	ONVIF, PSIA, CGI, ISAPI
Interface de sortie	Interface Réseau RJ45
Securité	Protection par mot de passe, Contrôle d'accès multi-utilisateurs
Général	
Alimentation	PoE: 0.30 A to 0.20 A, max: 7.5 W DC: 0.83 A to 0.20A, max: 7.5 W 9-36 V & PoE (802.3af, 36 V to 57 V)
Environnement	Température : -30 °C à 75 °C ; Humidité relative ≤90%
Dimensions	Φ 78.8 mm × 81.6 mm x 63.8 mm
Certifications	
Protection	IP68 (IEC 60529-2013)
Automobile et ferroviaire	EN50155-2017(EN 50155:2017, EN 50121-3-2:2016, IEC 60068-2-1:2007, IEC 60068-2-2:2007, IEC 60068-2-30:2005, IEC 61373:2010); EN45545 (EN 45545-2:2013+A1:2015); E-MARK (ECE R10)
Cybersécurité	
Certification interne	Cybersafe (cf. Cyber DS-2XM6222G1-ID R M2M.pdf)



DS-2XM6222G1-ID /R M2M

Caméra 2MP 110°, focale fixe 2.8mm, IR 850nm 10m, IP68, WDR 120dB, H265, grande tenue aux vibrations, Cybersafe

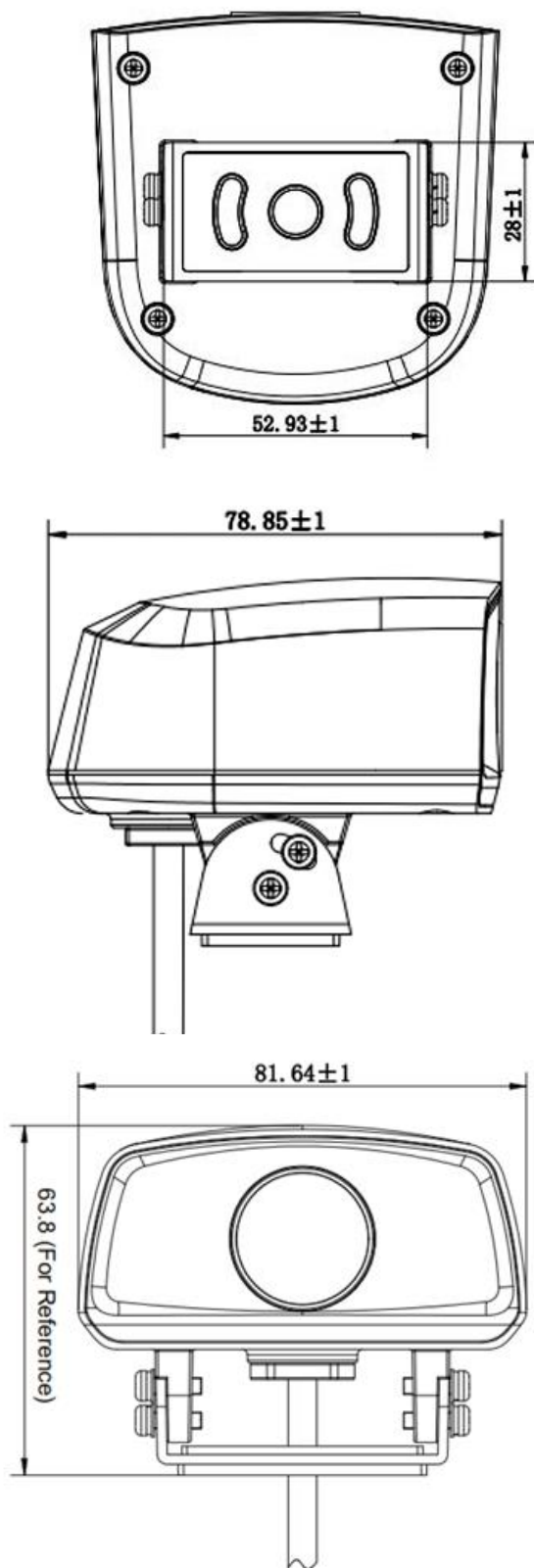

Unit: mm